

# WORLD MARKET®

## Assembly Instructions

### COREY BLACK WOOD MARBLE CONSOLE TABLE

SKU- 622479

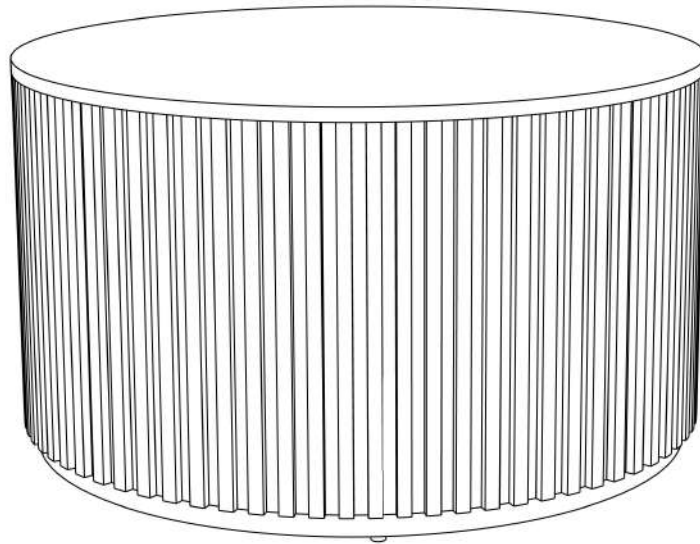

THANK YOU FOR YOUR PURCHASE. IF YOU HAVE ANY QUESTIONS  
PERTAINING TO THE ASSEMBLY OF THIS FURNITURE PIECE, PLEASE CONTACT  
THE NEAREST WORLD MARKET STORE.  
IF YOU ARE NOT NEAR A STORE, PLEASE CALL OUR CUSTOMER SERVICE CALL  
CENTER TOLL FREE AT 877- 967-5362 FOR ASSISTANCE.

**ALL PRODUCTS SOLD AT WORLD MARKET  
ARE NOT FOR COMMERCIAL USE AND ARE  
INTENDED FOR RESIDENTIAL USE ONLY.**

## Component List

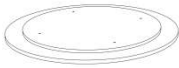
LABEL		DESCRIPTION	QTY
A		Wooden Base	1
B		Marble Top	1

## Hardware List

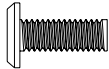
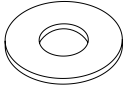
LABEL		DESCRIPTION	QTY
H-1		Allen Bolt (6mm x 35 mm)	4
H-2		Flat Washer (8 mm x 25 mm)	4

## Tool List

LABEL		DESCRIPTION	QTY
T-1		Allen Key (4 mm)	1

# Assembly Preparation

## Before Beginning:

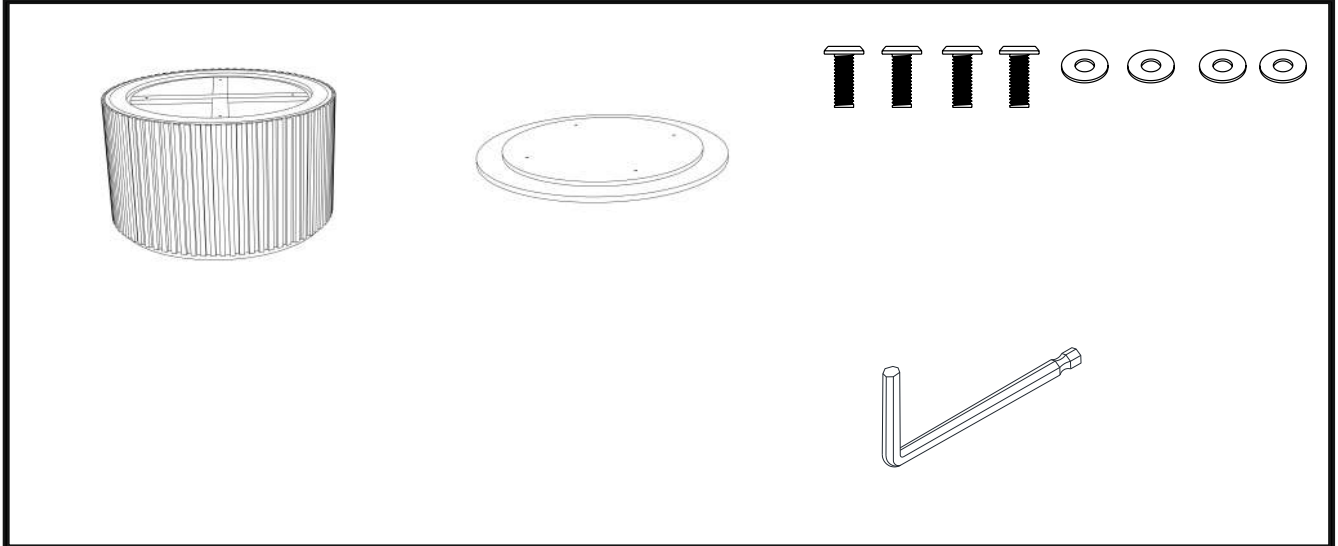

- Unpack all hardware bags and components to ensure you have all parts.



- Read instructions, cover to cover.



- Have 2 adults on hand for assembly.



- Do not assemble on flooring or carpet.



- Assemble on a clean non-marring surface (packing foam).



- Save all packaging until finished.



- In case of missing parts, please contact your nearest World Market store or call our customer service call center at call 1-877-967-5362.



- **WARNING: Small parts are a choking hazard. Adult supervision is required before, during and after assembly.**

# Assembly Steps

## Step-1

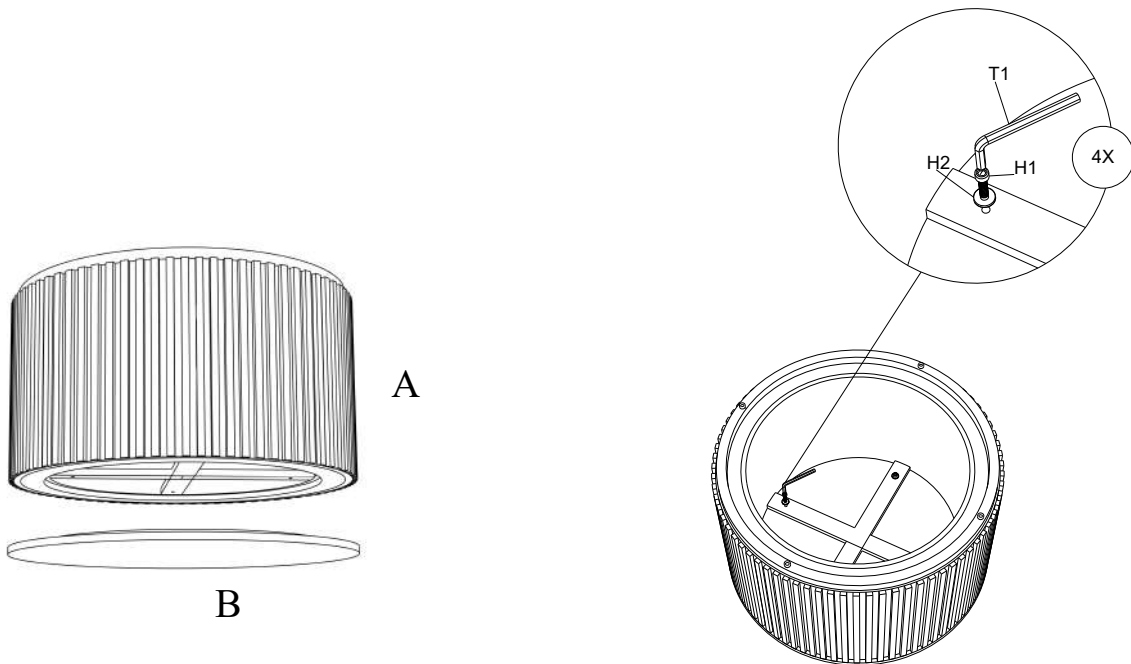

Place the MarbleTop (B) upside down position onto a padded non-marring surface. Align the hole of Marble Top(B) with pre-drilled holes underneath Wooden Base (A) and secure connection using Allen Bolts (H-1) and Flat Washer (H-2) with the help of Allen Key (T-1) . Adjust overhang of Marble Top (B) with Wooden Base (A). Now fully tightened all Bolts.



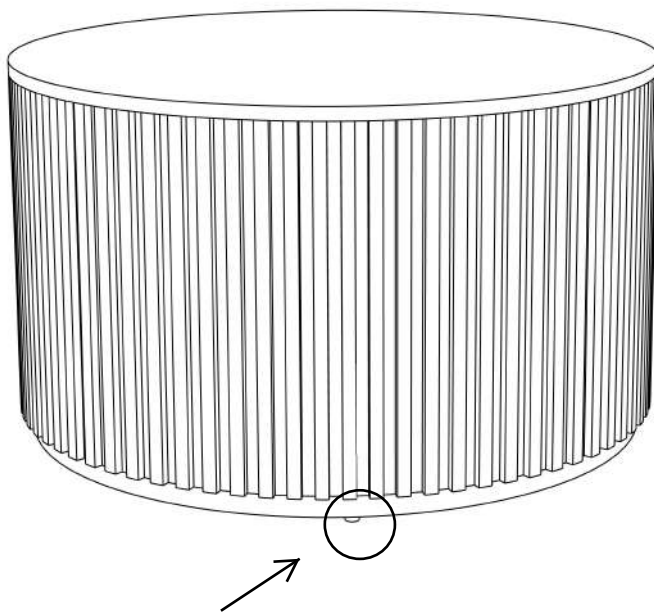

## Step-2



Note: Levellers are used for adjustment if needed.

Using a second person to assist you, carefully turn the table into upright position. Ensure the table sits evenly and all bolts have been fully tightened. Assembly is complete and the product is ready to use.

# Care & Maintenance

-  • Do not put hot items directly on furniture surface.
-  • Do not clean furniture with harsh cleansers or polish.
-  • Do not place furniture near heating or cooling vents.
-  • Do not write on furniture without a padded barrier to protect the surface.
-  • All products sold at World Market are not for commercial use and are intended for residential use only.

- 
-  • Dust and pick-up spills using a clean, non-colored, lint-free cloth.

**Note** • Recommend using coasters to protect table top. Wipe spills immediately with a soft, dry cloth.

# **WORLD MARKET** LIMITED ONE-YEAR WARRANTY – Indoor Furniture

For your customer satisfaction, this product carries a LIMITED ONE-YEAR WARRANTY from the date of purchase. This limited warranty only applies to World Market brand furniture, and not to other furniture brands sold on World Market's website.

Where applicable, the limited warranty provides coverage for:

1. **Manufacturing, Material and Workmanship Defects:** Includes defects related to core frame/structure substrates (wood and metal); cracking, splitting, or complete breakage of hardwood, plywood or medium density fiberboard (MDF); cracking, splitting or lifting of wood veneer or laminated top surfaces caused by process failure; broken welds or improperly coated metal frame components (powder coating or painted); fabric or leather material defects including tears, misprints, fraying, crease marks, skip stitches or open seams; support webbing material and sinuous spring defects or damage, including method of attachment to frame; and other component failures that are a direct result of manufacturing or workmanship defects.
2. **Cushions & Cushions with Enclosed Steel Pocket Coils:** Failed or ruptured steel pocket coils enclosed inside of seat cushions, or loss of resiliency from a material breakdown of foam or fiber filling, which should not be confused with softening or settling during normal use.
3. **Leather:** Splitting or cracking of leather material. NOTE: The warranty does NOT cover natural hide markings, variations in the leather color or grain due to the authentic natural properties of processed cowhide leather.
4. **Bonded Leather or Bi-cast Leather:** Separation of the polyurethane coating, peeling or cracking of the inner layer or at the bonded seam edges (bi-cast straps).
5. **Furniture Components (Hardware & Mechanisms):** Includes defects to pre-installed components or hardware provided to the customer for assembly such as office chair hydraulic lifts, lift mechanisms, metal bases and casters, swivel plate mechanisms; for drawers, metal glides, handles/knobs; for doors, hinges, magnetic latches; and other components such as bent or stripped threaded leg posts and adjustable levelers. For missing, damaged, corroded, or misplaced hardware components such as bolts or washers, please contact Customer Service at: 877-967-5362.

**This LIMITED ONE-YEAR WARRANTY does NOT cover:**

1. Damage due to mishandling during transportation from store or transportation without original protective packaging.
2. Abuse, negligence (product misuse) or wear and tear that may result in or from:
  - a. **Wood & Veneer:** Mishandling, exposure to moisture, peeling or discoloration caused by exposure to moisture or excessive sunlight, heat; splintered, dented or nicked panels, legs or component edges or paint/finish blemishes; or treatment with corrosive chemicals (dyes, inks, paints or harsh cleaning products).
  - b. **Fabric & Leather (Including Bonded or Bi-Cast Leathers):** cuts, punctures, tears, burns, pet damage, or treatment with corrosive chemicals (dyes, inks, paints or harsh cleaning products), exposure to direct sunlight, fire, high heat, water, or any bright light source (natural or artificial) that may cause splitting, peeling or flaking with time.
  - c. **Foam (Cushions):** Flattening, relaxing or settling/softening of foam components that comes with normal use.
  - d. **Hardware Components:** improper installation or misuse/substitution of hardware components not defined in the Assembly Instructions for the product (if applicable)
3. Damage due to environmental exposure to direct sunlight, fire, high heat, water or extreme humidity, any bright light source (natural or artificial), or any environment that the product is not intended for.
4. This warranty is applicable for indoor furniture products purchased for residential use only.

For additional information on returns, please visit: <https://www.worldmarket.com/category/customer-service/returns.do>

**All products sold at World Market are NOT FOR COMMERCIAL USE and are intended for residential use only. Products purchased for commercial use will VOID all warranty provisions as listed above.**

Any claims under this LIMITED ONE-YEAR WARRANTY are valid and applicable only as to the original purchaser and must be accompanied by proof of purchase. Warranty claims should be submitted to a World Market store or through World Market Customer Service Call Center, Toll Free at 877-967-5362.

For valid warranty claims, World Market will repair or replace the product, or offer a full or partial credit, in the sole discretion of World Market. This LIMITED ONE-YEAR WARRANTY gives you specific legal rights and you may also have other rights which vary from state to state.